

# MDRXX

MICRO DYNAMIC RIFLE EXTREME

## user manual

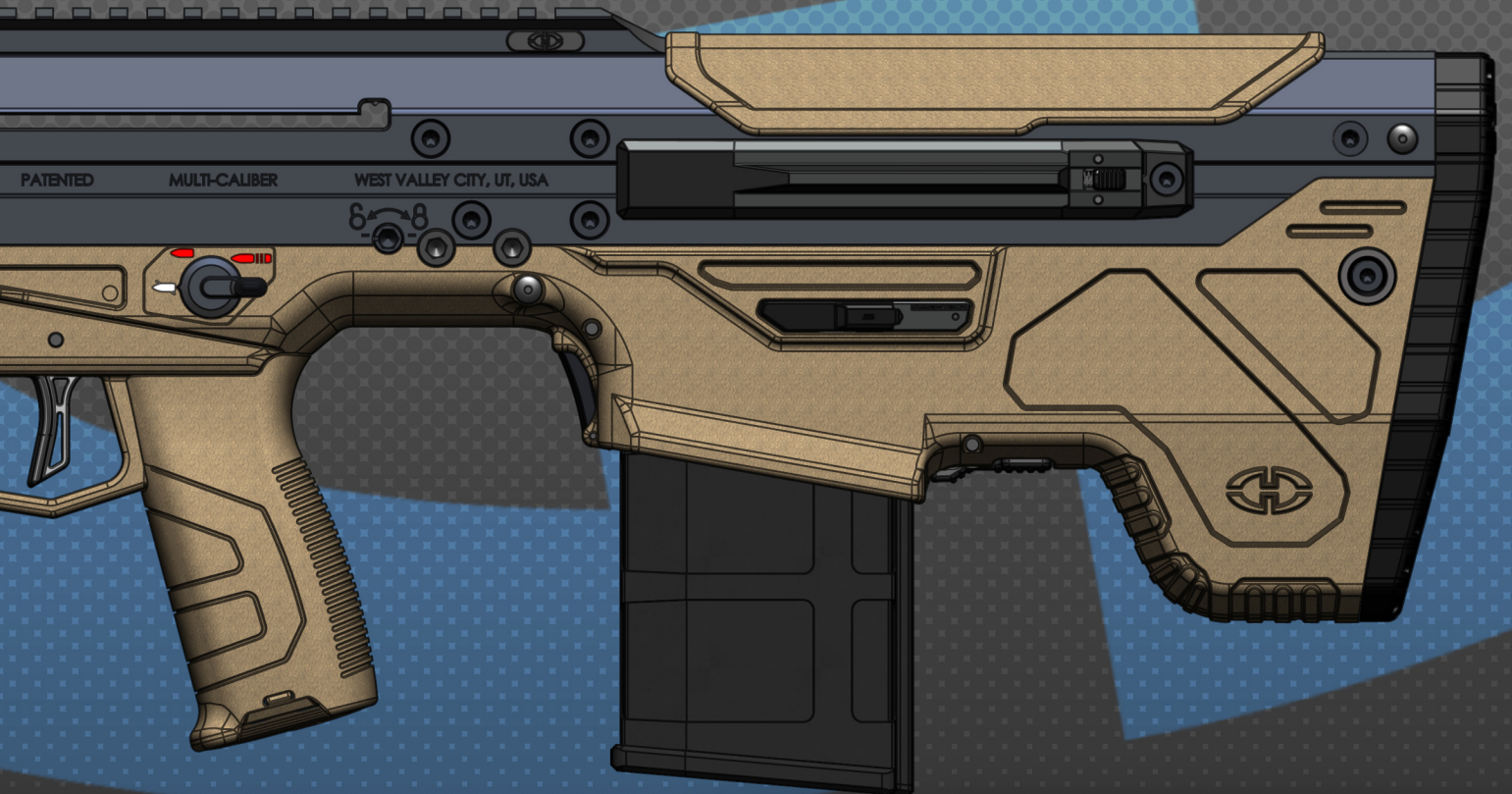

DESERTTECH<sup>®</sup>  
TOMORROWS WEAPONS

# MDR X EXTREME

MICRO DYNAMIC RIFLE



# TABLE OF CONTENT

SAFETY.....	4
WARNINGS.....	4
DT & MDRX PRESENTATION.....	5
BOX CONTENT.....	6
GUN DESCRIPTION.....	6
BATTERY INSTALLATION.....	7
MAGAZINE.....	8
SELECTOR.....	9
SHOOTING OPERATION.....	9
HOPUP ADJUSTMENT.....	10
ADVANCED SETTINGS & ERGONOMICS.....	11
EXPLODED VIEWS.....	12
MATERIALS / MASS / SIZE / CAPACITY.....	13
DIGITAL VERSION.....	14



MICRO DYNAMIC RIFLE EXTREME

# SAFETY

**READ THIS MANUAL CAREFULLY AND THOROUGHLY BEFORE USE**, users should obey to laws regarding the usage and ownership of airsoft guns in their country. Misuse or careless use may cause serious injuries. Always treat airsoft guns as if they are loaded and with the same respect as you would treat firearms. Do not look into an airsoft gun muzzle. Never point the airsoft gun at something you do not intend to shoot. Users should always wear safety glasses. Always carry the airsoft gun in a bag or a case and never display it in public places. Always keep the airsoft gun in "safe" mode until you are ready to shoot at a safe direction. Always check that the airsoft gun is in "safe" mode and unloaded when getting it from another person or from storage. Do not put the airsoft gun away or in storage while it is still loaded. Do not shoot at hard surfaces or water surfaces as bbs could bounce or ricochet and hit someone or something you do not intend to hit. Always use high quality 6mm plastic bbs and never use already shot bbs as it may damage your airsoft gun. Always store airsoft guns in a secure place and out of reach from children. Do not attempt to modify or alter your airsoft guns, as doing so may make your airsoft gun unsafe to use and/or cause serious injuries and/or void the warranty. **WE ARE NOT RESPONSIBLE FOR ANY MALFUNCTION, ACCIDENTS, INJURIES OR REPAIR COST RESULTING FROM MISUSE, DISASSEMBLY AND/OR MODIFICATION OF THIS AIRSOFT GUN.**



## WARNINGS

- Make sure the battery is disconnected before making any checks or maintenances.
- Unplug the battery when the gun is not in use (for safety and battery drainage reasons).
- Take care of the cables when closing the lower receiver to avoid damaging them.
- If your battery is worn out, and/or the temperature is very cold, and/or the power spring is very stiff, the battery protection might need to be disabled in order to cycle properly the gearbox. Please refer to our Youtube video tutorial.
- If you remove the battery protection, you may damage your battery if you discharge it too much while shooting or keeping the battery connected for a long period of time.
- In case of jam or malfunction, be sure to clear it before trying to shoot again.
- If using 7.4 V Lipo battery, be sure to place the jumper accordingly on to the PCB.
- Do not attempt to operate the selector when the trigger is being pulled as this may cause the gun to malfunction.
- If the gearbox jams, reset the PCB by disconnecting the battery for 10 seconds.
- If the firing cycles are incomplete, it is time to recharge the battery.
- Do not overload the magazine or you will damage the magazine spring.
- Avoid to store the magazine fully loaded for a long period of time.
- Maximum torque for the 3 barrel screws is 3Nm. Excessive torque may damage the receiver, please refer to the exploded views.
- Do not apply any grease/oil inside the hopup and/or the barrel.
- By construction, the handguard is not precisely coaxial with the receiver, therefore the barrel could be off-centered in the handguard while being centered in the receiver. Optics must be attached to the gas-block or the receiver, not to the handguard.
- For long term storage, make sure the spring is not under tension by pressing the anti reversal, and remove the battery from the gun.

# DESERT TECH<sup>®</sup>

## ▶ TOMORROWS WEAPONS ▶

Desert Tech, formerly Desert Tactical Arms, has been building a better rifle since 2007 when we realized the demands of future battlefields exceeded the capabilities of current platforms. We decided then to build our rifles more accurate, more compact, more convertible for an increasingly complex world.

Our R&D department is tasked daily to fuse ground-breaking engineering with American ingenuity so that skilled machinists on state-of-the-art mills and lathes can shape battle-tested materials into Tomorrow's Weapons. Each Desert Tech rifle that enters our network of nationwide dealers and international distributors is both ergonomically and ballistically superior to any other production rifle on the planet.

Desert Tech also offers select, premium, match-grade munitions as well as world-class precision instruction across the 25,000 acres of natural terrain and sophisticated training bays at our private facility. These features compliment a complete package of detail-driven customer service for the modern-day warrior, hunter or competition shooter who demands peak performance with each and every trigger press of a Desert Tech SRS, Covert, HTI or MDR.

From concept to recoil, we are creating uncommon and uncompromising firearms with the sole intent of arming serious shooters to the very edge of their abilities and beyond. At Desert Tech, we're building Tomorrow's Weapons and it begins with a better rifle today.

The MDR is designed for future defense needs. Its compact size and superior ergonomics maximize its portability without sacrificing speed, power, or precision. The MDRX allows mission specific adaptability by changing the rifle's length, sound signature and/or caliber. Its fully ambidextrous design allows seamless shoulder transition.

The MDRX delivers advanced firepower for the future patriot.

### Portable

The MDRX has unrivaled portability because it is lightweight, compact, ergonomic, and balanced with an overall length of 27.6" (702 mm) and a weight of 8.3 pounds (3.76 kg).

### Adaptable

The MDRX is adaptable in both size and caliber. It can quickly convert between multiple calibers, and the barrel is truly free-floated by design so barrel whip does not affect accuracy.

### Ambidextrous

The MDRX is fully ambidextrous with no modification necessary. Our patented forward ejection mechanism and intuitive controls set a new bullpup standard for speed and precision.

### Multi Caliber

The MDRX can be converted within a few minutes to any of the available calibers.

### Side Eject

The side eject can be converted easily from right and left handed and has an improved center of balance.

*Nicholas E Young*



# BOX CONTENT

- MDR-X airsoft replica,
- User manual,
- 78 rds AR-10 «7.62» polymer magazine,
- SPR-1060 Spring (60 Newton, 1.1 Joule)\*,
- SPR-1100 Spring (100 Newton, 1.8 Joule)\*,
- Single only trigger PCB\*,
- Pin puncher,
- 2.5 mm & 5 mm Allen keys,
- T20 & T25 Torx keys,
- PCB Jumper,
- High nub,
- Patch.

(\*): Box content may vary depending on different countries regulations.

# GUN DESCRIPTION

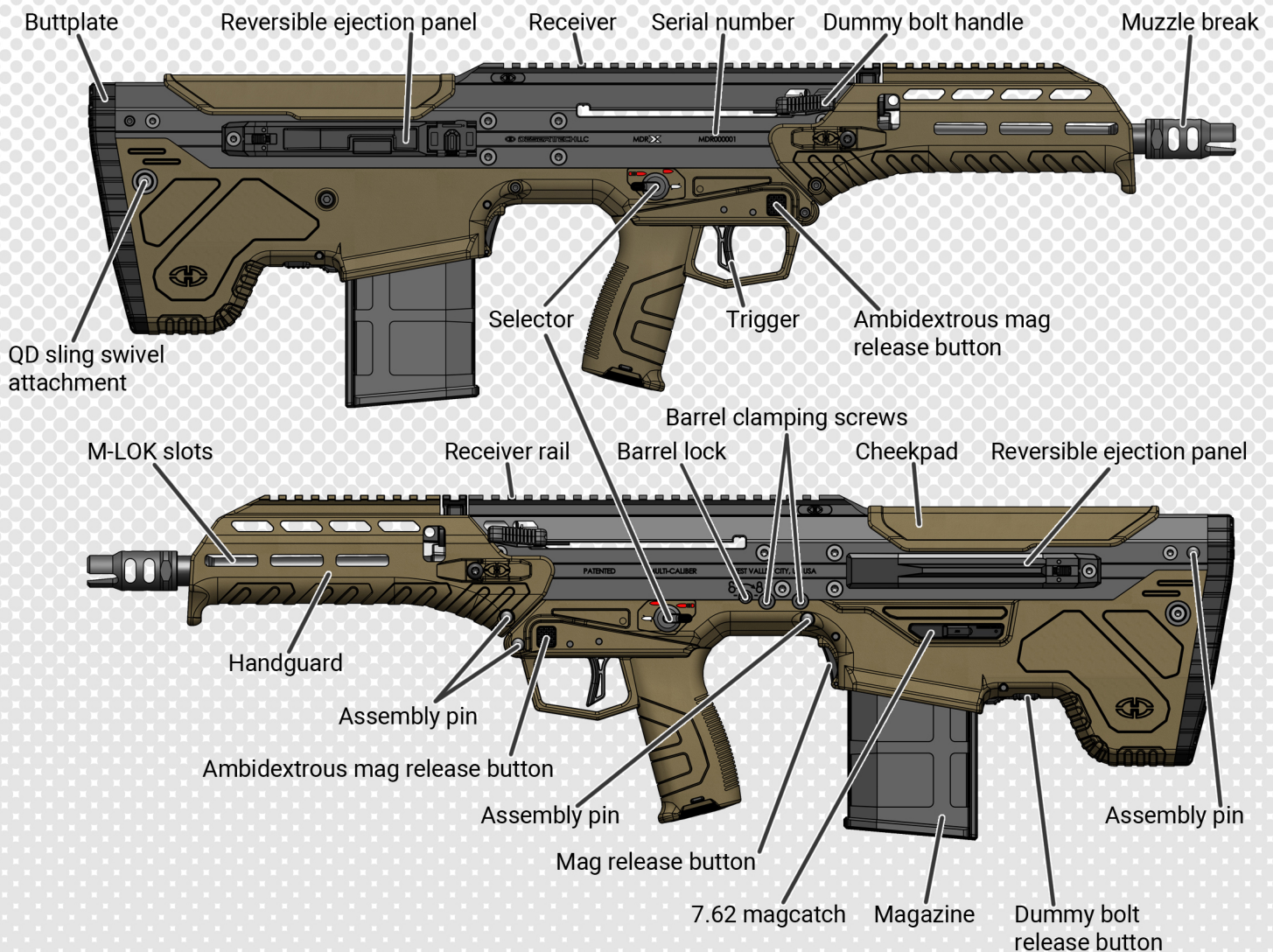

# BATTERY INSTALLATION



Remove the magazine and punch out the two assembly pins as shown (the pins will auto lock themselves when disengaged).

Open the lower receiver.

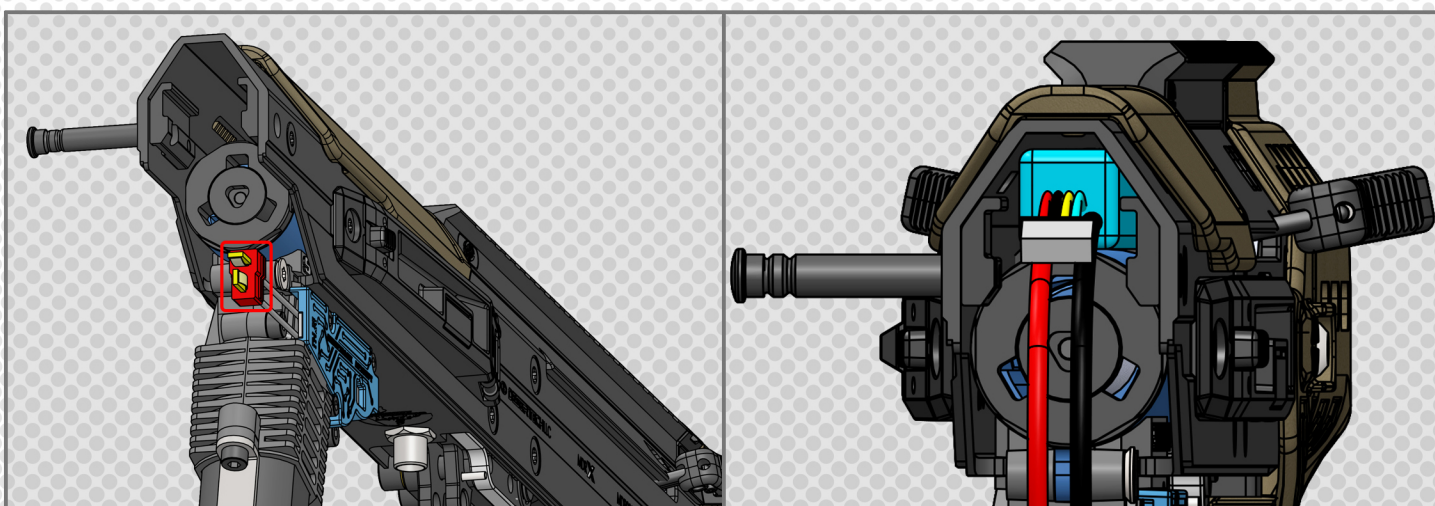

Plug your 11.1 V battery into the T-socket of the PCB. (Note that battery is not provided.) If you wish to use 7.4 V battery, please refer the dedicated video on our Youtube channel.

The battery can be stored in the battery bay located above the gearbox.

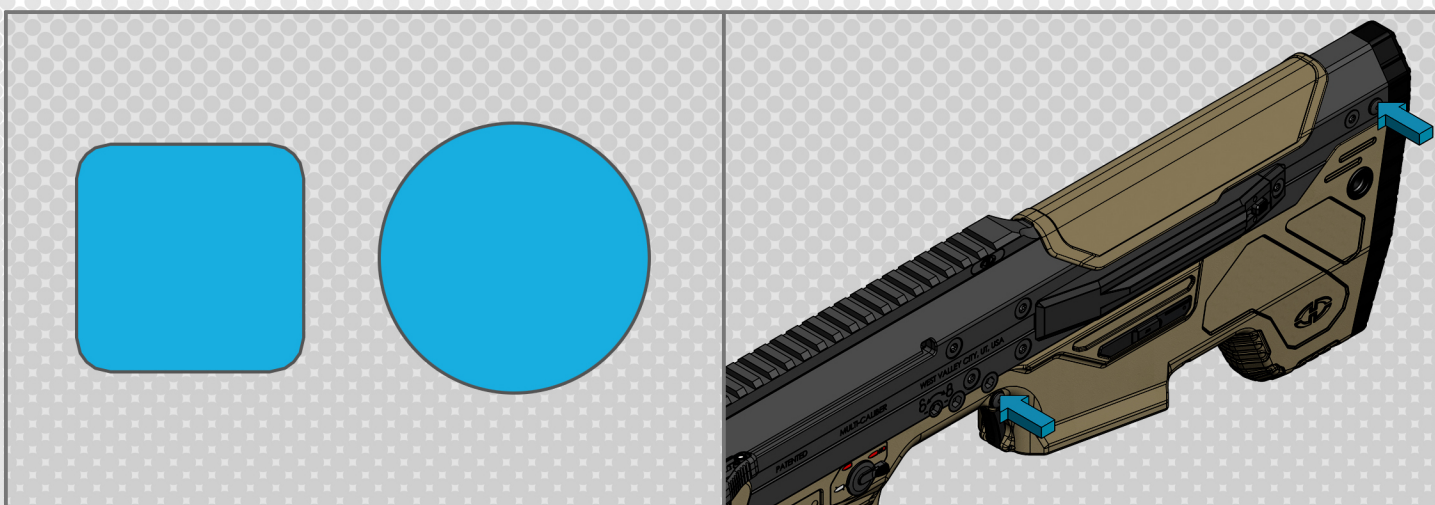

Maximum profile dimension for the battery:  
- Square profile: 16 x 16 mm  
- Circular profile: 17.5 mm diameter.  
Maximum length: 190 mm.

Close the lower receiver, push firstly the buttplate assembly pin back into position, then the magwell assembly pin.  
**WARNING:** take care of the battery wires.

# MAGAZINE

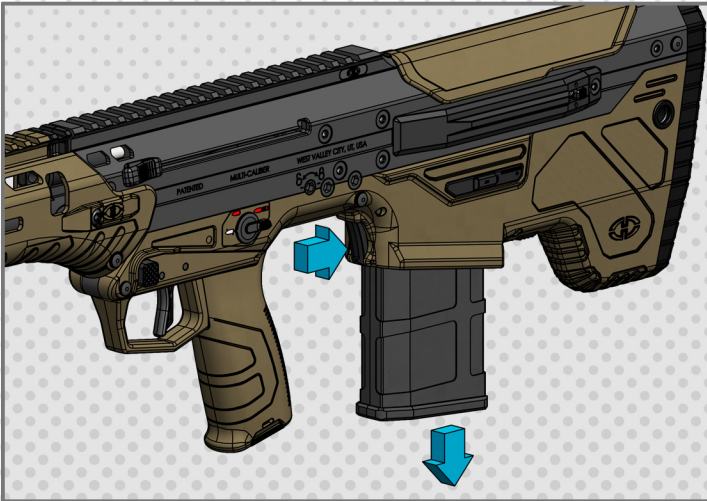

To remove the magazine, push down on the magcatch button and pull out the magazine.

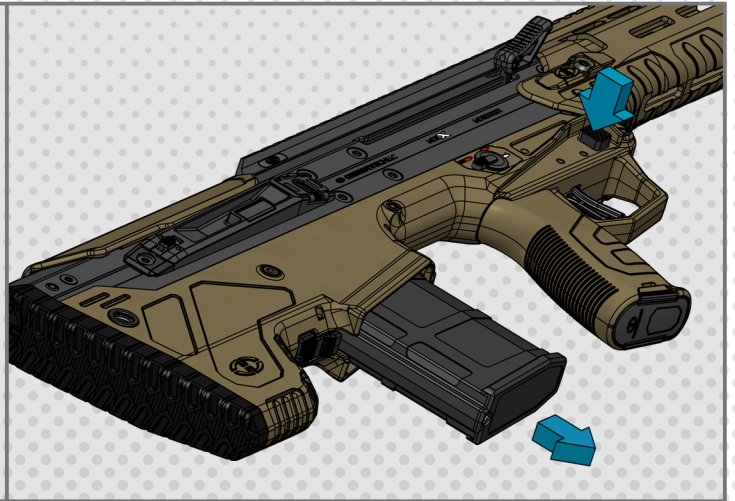

You can also remove the magazine by pressing the ambidextrous mag release button on the right side.

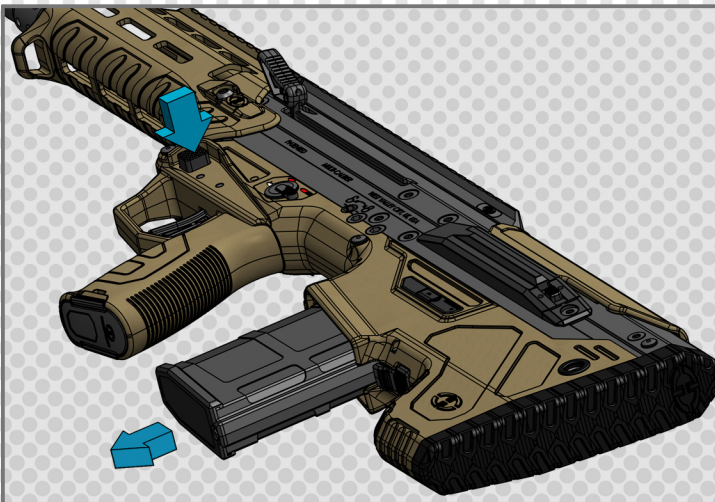

You can also remove the magazine by pressing the ambidextrous mag release button on the left side.

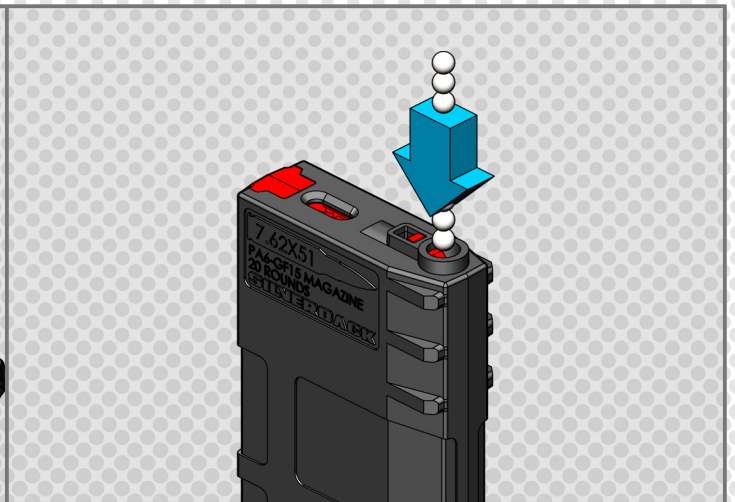

Load the magazine with a bb-loader (78 bbs capacity).

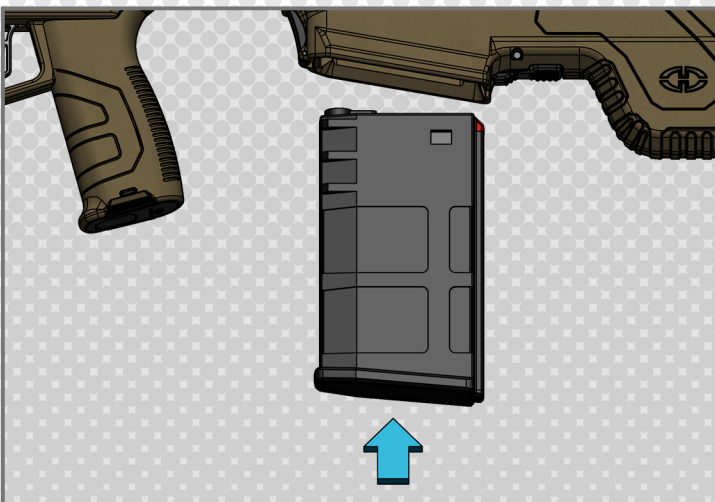

Insert the magazine firmly into the magwell until the magcatch locks it in place.

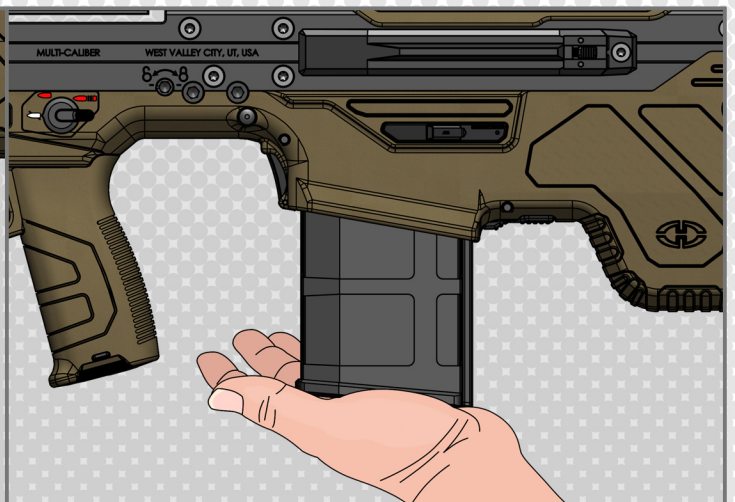

Slap the magazine and check to see that the magcatch is well engaged.



# SELECTOR

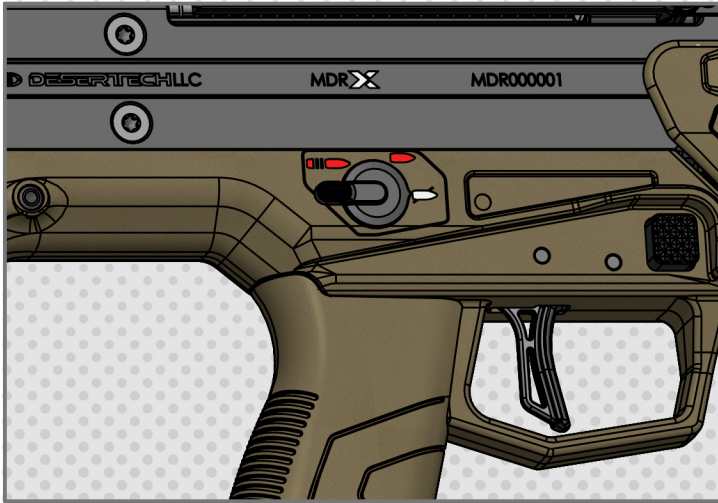

Safe mode, the trigger is mechanically locked and the gun cannot shoot.

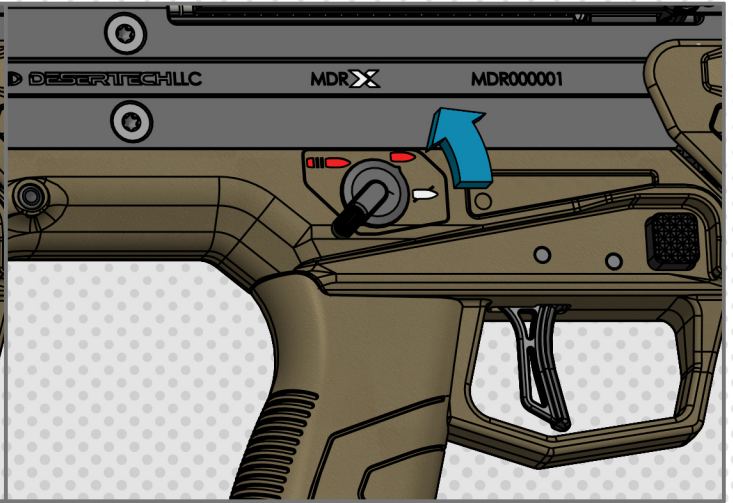

Semi-automatic mode, the gun will shoot once per trigger pull.

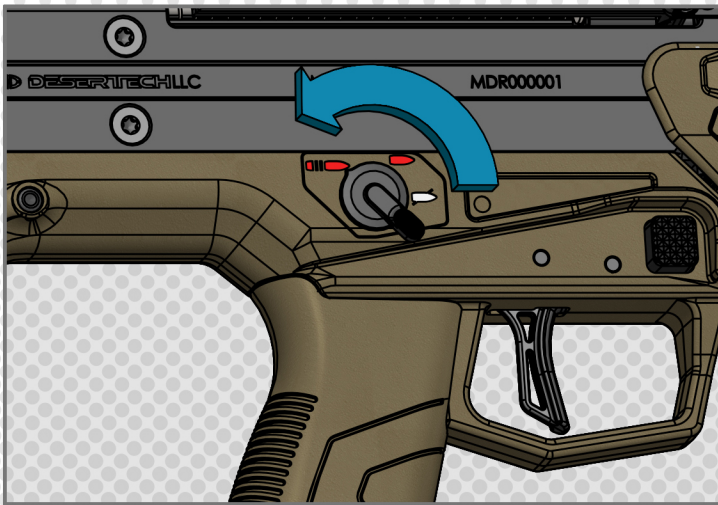

Full-automatic mode, the gun will shoot for as long as the trigger is pulled. NOTE: for the German market, full auto mode is disabled.

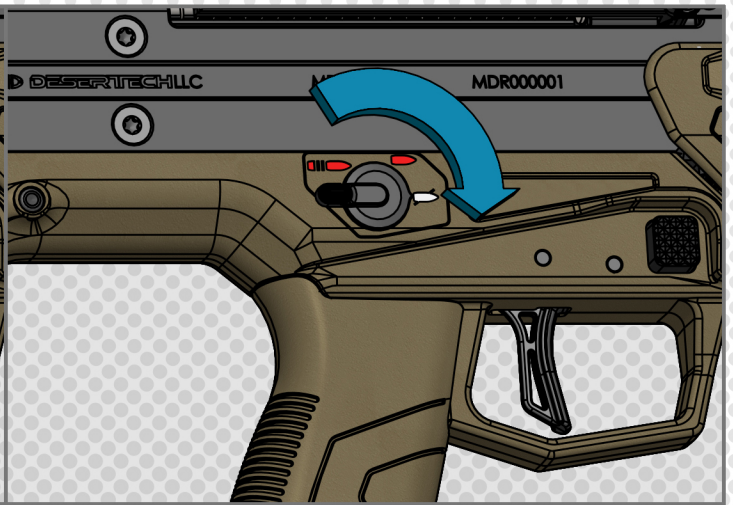

Always switch the selector to safe mode except if you intend to shoot.

# SHOOTING OPERATION

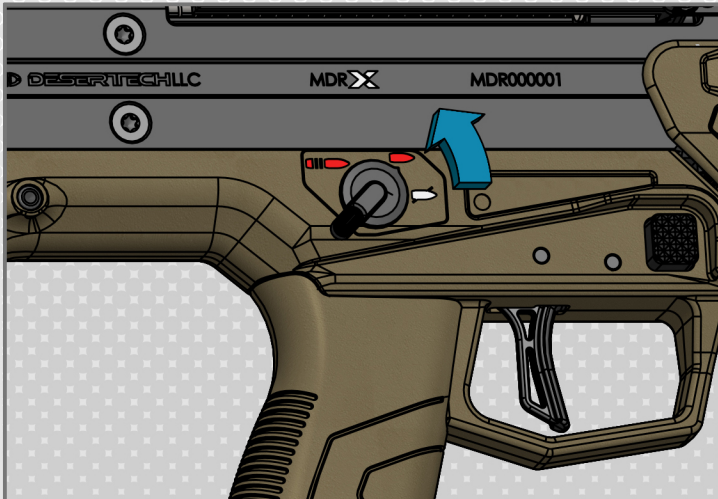

Turn the selector to one of the two firing modes.

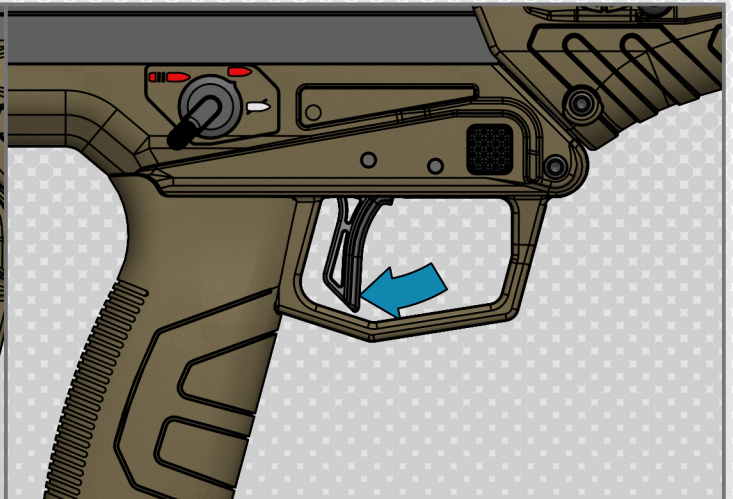

Pull the trigger to fire.

# HOPUP ADJUSTMENT

Each «click» increases/decreases the hopup preload by about 21  $\mu\text{m}$ . There are 36 positions for the hopup wheel, ranging from 0 up to 750  $\mu\text{m}$  with the low nub (installed), and from 500 up to 1250  $\mu\text{m}$  with the high nub (provided). Please refer to the dedicated video on our Youtube channel.

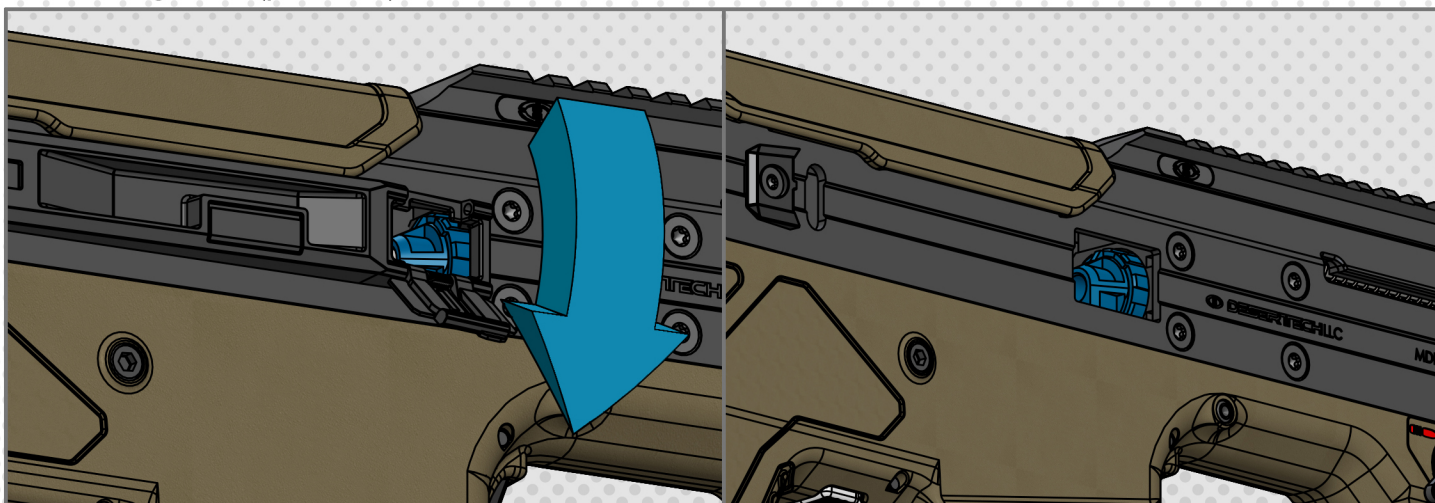

The Hopup can be accessed from the ejection panel window.

You may also remove the ejection panel for easier access to the Hopup.

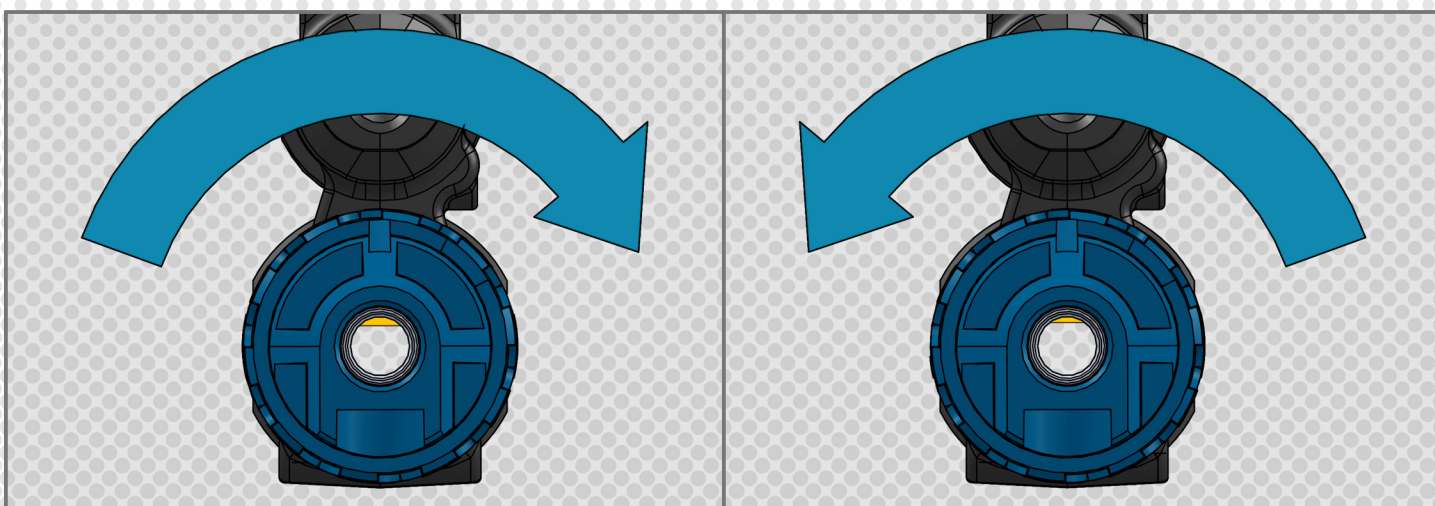

Turn the Hopup in clockwise direction to increase Hopup effect.

Turn the Hopup in counterclockwise direction to reduce Hopup effect.

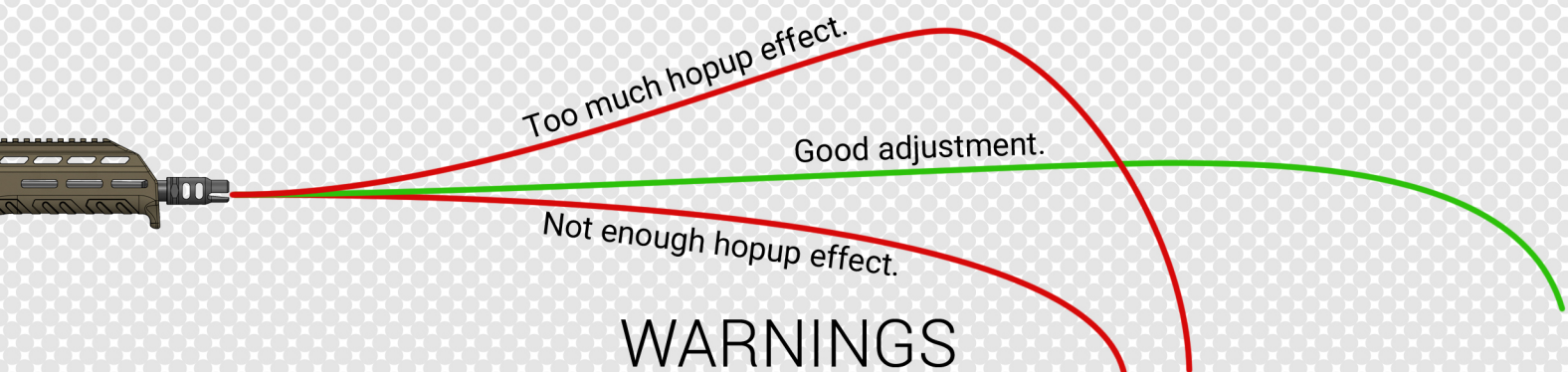

## WARNINGS

- Hopup adjustment needs to be done every time you change the BBs mass or the muzzle energy.
- Excessive hopup adjustment will jam the gun.
- In case of jam:
  1. remove the magazine,
  2. turn the hopup wheel to minimal preload,
  3. shoot in a safe direction to clear the hopup,
  4. adjust the hopup again.
- Hopup adjustment may affect your muzzle energy: always check your muzzle energy after adjusting your hopup using in-game bbs and make sure it is within the limits of your local law/rules.
- It is mandatory to keep your hopup clean and dry to be effective.
- To avoid any sidespin, be sure to hold your rifle straight before to pull the trigger.

# ADVANCED SETTINGS & ERGONOMICS

To help you with the ergonomics and advanced settings, please check out our YouTube channel for the video tutorials. Scan the QR code on this page to access our YouTube channel.

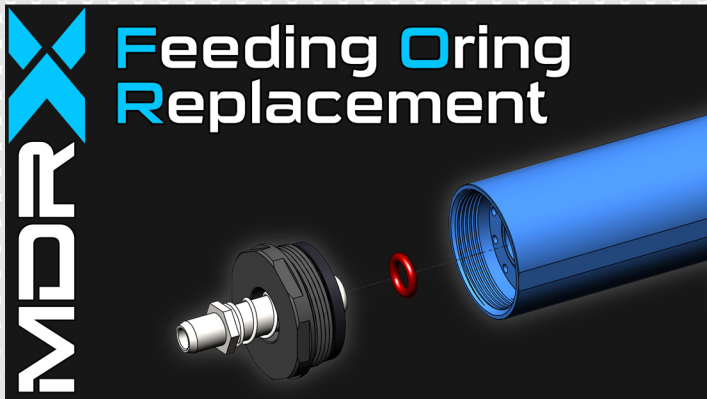
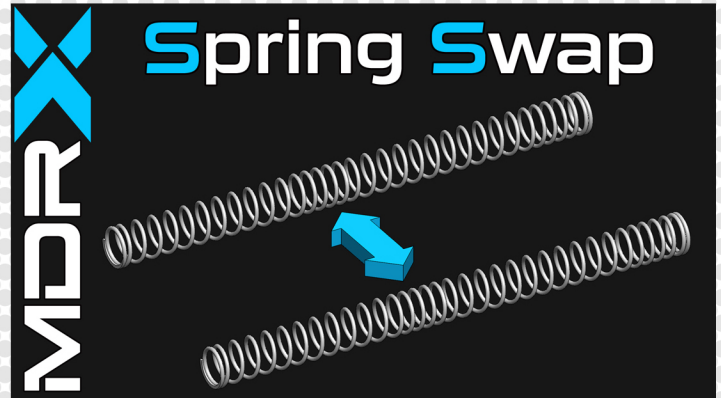
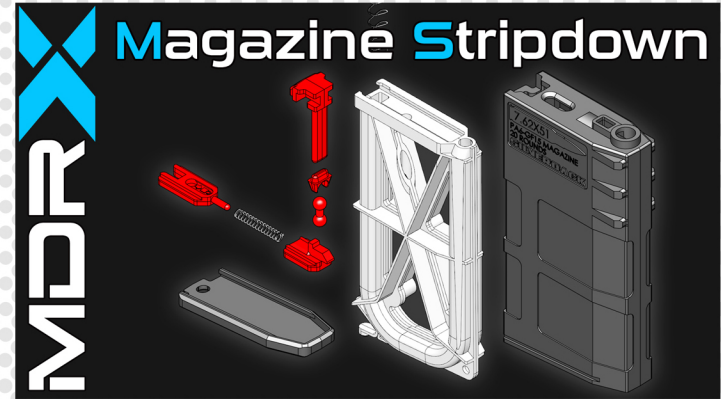
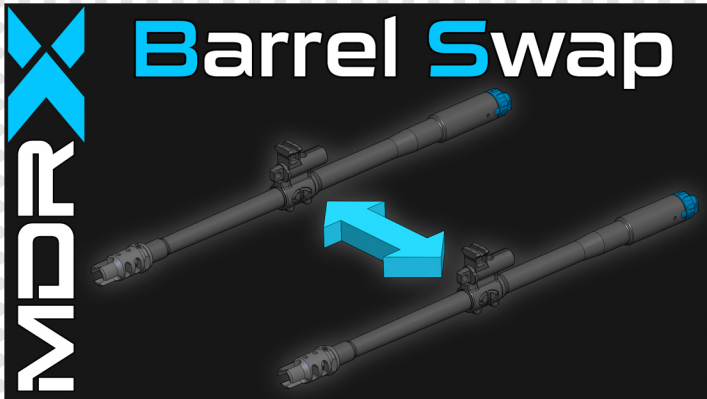
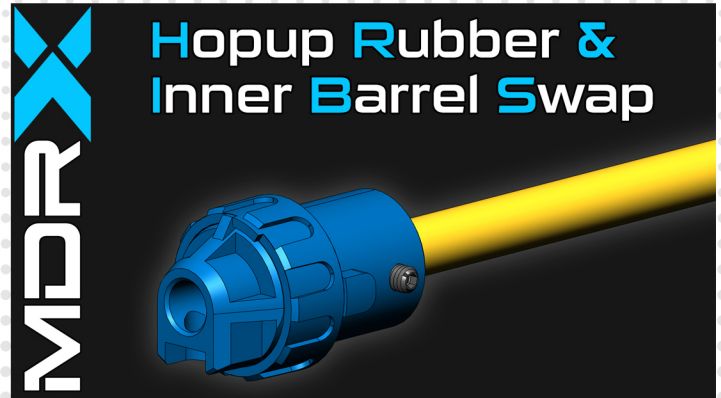
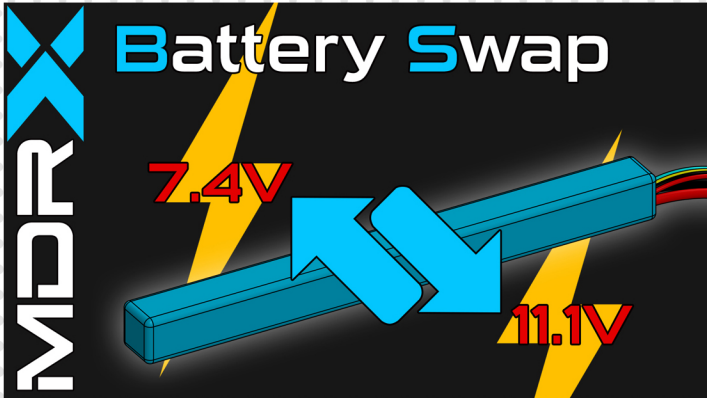

# EXPLODED VIEWS

MDR-0100-00  
UPPER  
RECEIVER

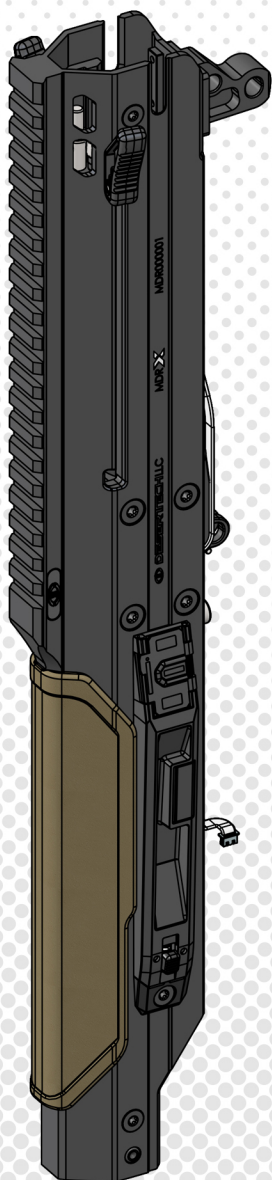

MDR-1500-00  
HANDGUARD

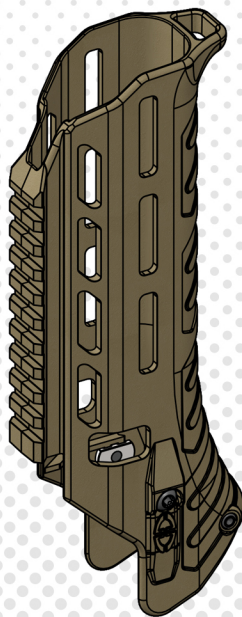

Scan this QR code to  
access the detailed  
exploded view.

MDR-1300-00  
BARREL

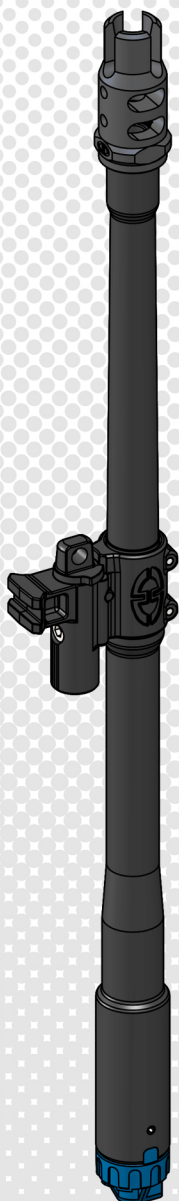

MDR-0200-00  
LOWER  
RECEIVER

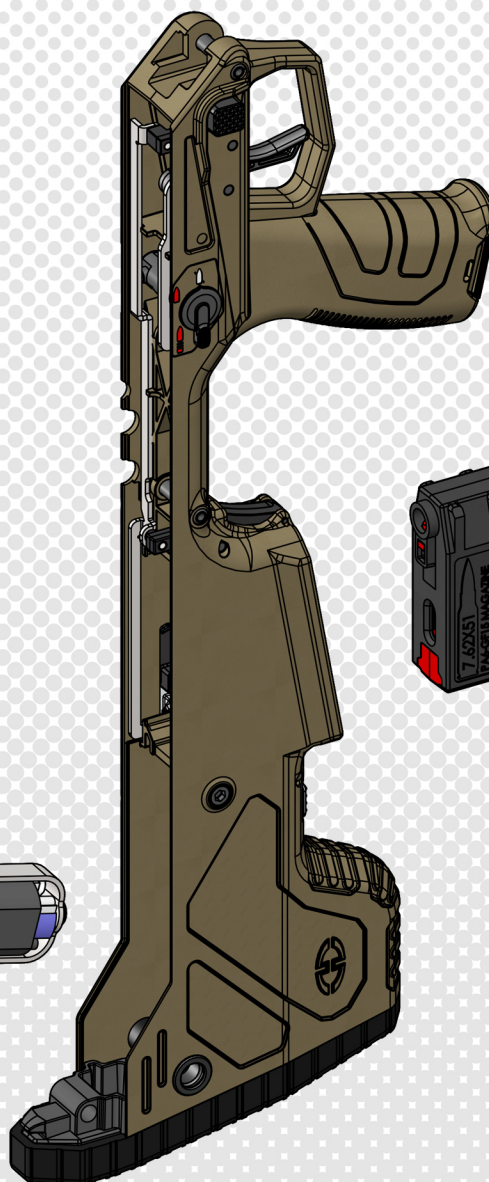

GB1-000000  
MDR GEARBOX

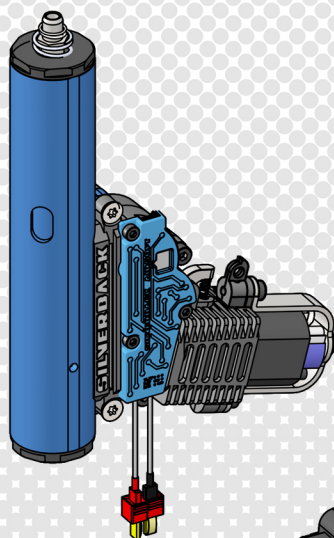

MDR-1800-00  
7.62 MAGAZINE

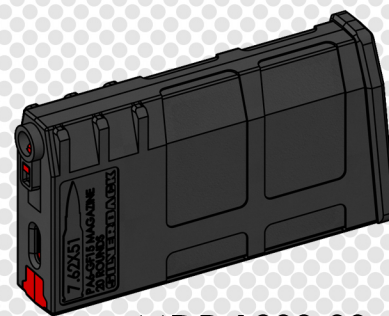

# MATERIALS / MASS / SIZE / CAPACITY

	buttplate	cylinder assembly	dummy bolt handle system	ejection panels	feeding tube	gearbox casing	gears	hardware	hopup	inner barrel	magazine	magazine release system	nozzle	orings	outer barrel assembly	PCB	piston	QD sockets	receiver	selector assembly	spring guide	springs	stock, grip & handguard	trigger assembly	trunnion assembly
aluminium 6000 series																									
aluminium ADC-12																									
steel CR1018																									
stainless steel SS304																									
steel 10.9																									
steel A228																									
MIM 4605																									
brass																									
nylon PA6-GF15																									
polycarbonate																									
POM																									
ABS																									
NBR 70° / 80°																									
silicone 70°																									
FKM																									
polyurethane																									

CATEGORY #	CATEGORY NAME	[gram]
MDR-0100-00	UPPER RECEIVER	840
MDR-0200-00	LOWER RECEIVER	560
MDR-1300-00	16" BARREL	460
MDR-1500-00	16" POLYMER HANDGUARD	120
MDR-1800-00	7.62 MAGAZINE	145
GB1-000000	GEARBOX	580
MDRX 16"	TOTAL	2705

Mass tolerances: +/- 0.2%

SIZE	[mm]
MDRX 16"	702
16" inner barrel (AEG type)	420

Size tolerances: +/- 0.2%

CAPACITY	[bbs]
7.62 magazine	78
Feeding tube	4

# DIGITAL VERSION

Scan this QR code and download the digital version of the user manual. In case of user manual updates, this link will provide you with the latest version.



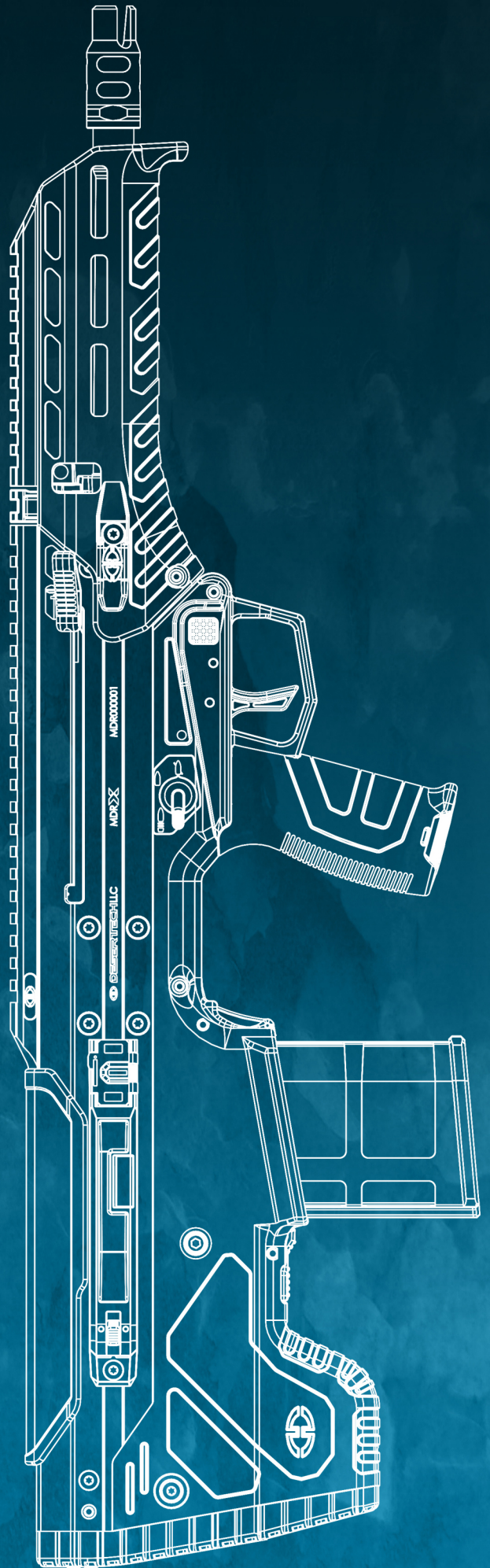
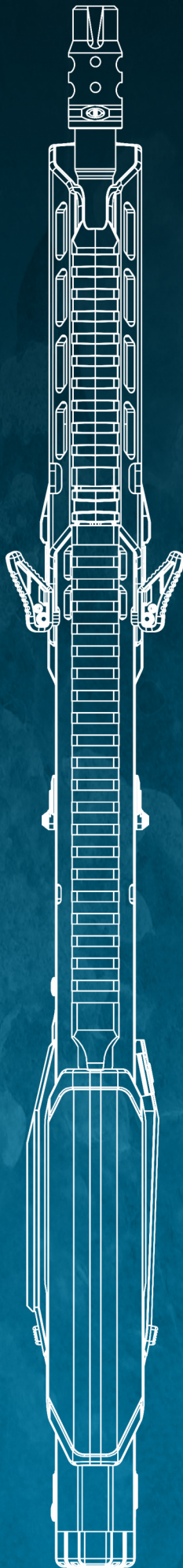
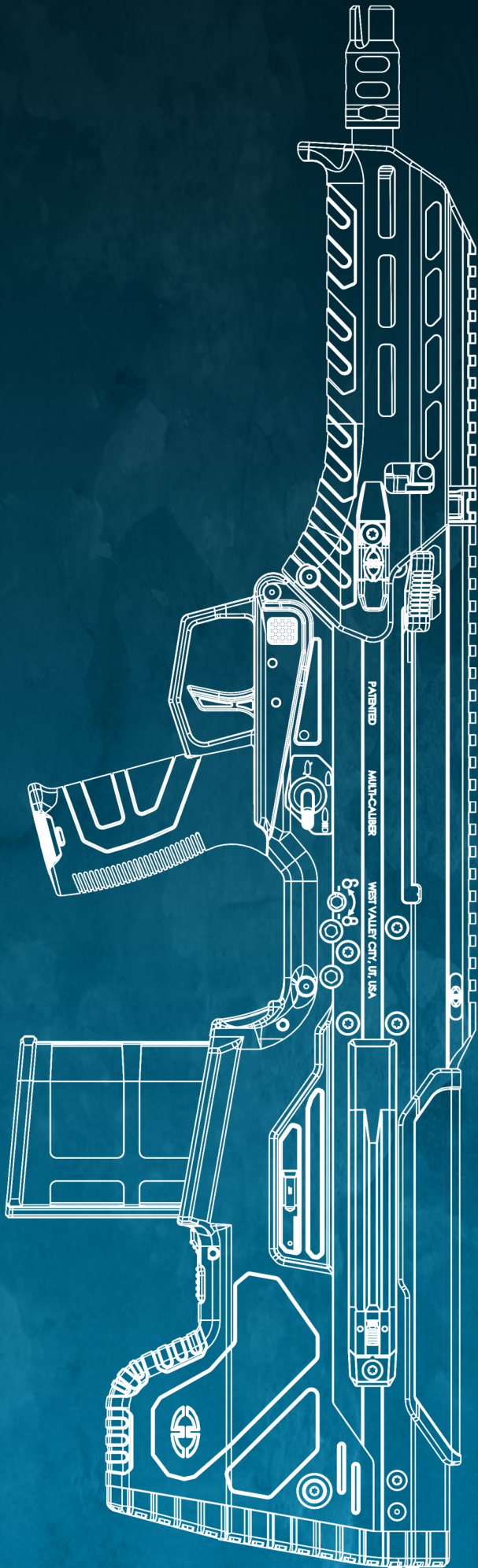



December 2022 - Made in China

**SILNERBACK AIRSOFT**